

PF/EC

Ventiladores centrífugos de alta eficiencia tipo Plug Fan, equipados con motor EC Technology IE5 con electrónica integrada

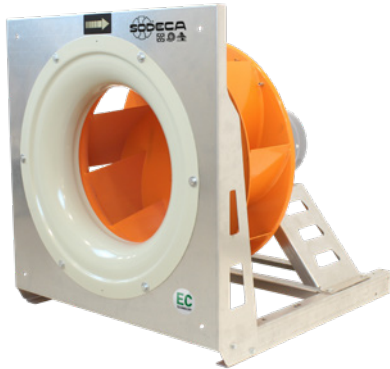

Ventiladores centrífugos de alta eficiencia tipo Plug Fan, para aplicaciones de tratamiento de aire, equipados con motor EC Technology IE5 con electrónica integrada especialmente diseñados para obtener una alta eficiencia energética.

Ventilador:

- Estructura en chapa de acero galvanizado.
- Turbina a reacción en chapa de acero.
- Preparado con toma de presión para el control automático de caudal.
- Ejecución vertical no disponible para los tamaños 1871.

Motor:

- Motores EC Technology de alta eficiencia con electrónica integrada, regulables mediante 0-10 V o 4-20 mA.
- Motores con eficiencia IE5, clase F y protección IP55.
- Monofásico 230 V 50/60 Hz y trifásico 400 V 50/60 Hz.
- Temperatura de trabajo: -20 °C +60 °C.
- Modbus RTU y relé de alarma incorporados (modelos trifásicos).

EC CONTROL: Se suministra como accesorio opcional. Cuadro de control para sistemas de ventilación con motores EC Technology que lleven la electrónica integrada en el propio motor. Con las siguientes características:

- CPC: Control de presión constante.
- CFC: Control de caudal constante.
- DAY/NIGHT: Ajuste de doble consigna de presión según momento del día.
- Sensor externo: Compatible con sensor de temperatura, humedad, calidad de aire o CO.
- Equipo preconfigurado en modo presión constante con set point de 100 Pa.

Acabado:

- Anticorrosivo en chapa de acero galvanizado.



MOTOR EC TECHNOLOGY con electrónica integrada



EC CONTROL Suministro como accesorio opcional

Código de pedido

PF/EC	—	H	—	1856	—	4T	—	5.5	—	IE5
↓		↓		↓		↓		↓		↓
PF/EC: Ventiladores centrífugos de alta eficiencia tipo Plug Fan, equipados con motor EC Technology IE5 con electrónica integrada		H: Montaje con bancada. V: Montaje vertical con soporte araña.		Tamaño turbina		Número de polos motor 2=3000 r/min 50/60 Hz 4=1500 r/min 50/60 Hz 6=900 r/min 50/60 Hz		Potencia motor (CV)		Motor IE5
						T = Trifásico M = Monofásico				

Características técnicas

Modelo	Velocidad (r/min)	Intensidad máxima admisible (A)		Potencia instalada (kW)	Caudal máximo (m³/h)	Nivel presión sonora¹ (dB (A))	Peso aprox. (Kg)	According ErP*
		230V	400V					
PF/EC-925-2M-0.5-IE5	3000	3,30		0,37	2180	61	24	2020
PF/EC-925-2T-0.5-IE5	3000		1,12	0,37	2180	61	22	2020
PF/EC-1028-2M-1-IE5	3000	5,90		0,75	3255	64	24	2020
PF/EC-1028-2T-1-IE5	3000		2,20	0,75	3255	64	20	2020
PF/EC-1028-4M-0.33-IE5	1500	2,30		0,25	1630	49	22	Excluded
PF/EC-1028-4T-0.33-IE5	1500		0,72	0,25	1630	49	20	Excluded
PF/EC-1031-2T-2-IE5	3000		4,22	1,50	4540	68	24	2020
PF/EC-1031-4M-0.33-IE5	1500	2,30		0,25	2270	53	23	2020
PF/EC-1031-4T-0.33-IE5	1500		0,72	0,25	2270	53	22	2020
PF/EC-1135-2T-4-IE5	3000		8,17	3,00	6670	71	43	2020
PF/EC-1135-4T-0.5-IE5	1500		1,06	0,37	3335	56	34	2020
PF/EC-1240-2T-5.5-IE5	3000		10,77	4,00	9300	75	40	2020
PF/EC-1240-4T-0.75-IE5	1500		1,56	0,55	4650	60	29	2020
PF/EC-1445-4T-1.5-IE5	1500		3,07	1,10	6775	64	41	2020
PF/EC-1650-4T-3-IE5	1500		5,96	2,20	10290	77	67	2020
PF/EC-1856-4T-5.5-IE5	1500		10,62	4,00	15480	71	90	2020
PF/EC-1663-4T-5.5-IE5	1420		10,62	4,00	19770	76	97	2020
PF/EC-1871-6T-3-IE5	900		5,96	2,20	16320	74	160	2020

¹ Nivel de presión sonora irradiada en dB(A) a 3 m de distancia a caudal máximo.
* Según borrador ErP 2020



Erp. (Energy Related Products)

Información de la Directiva 2009/125/EC descargable desde la web de SODECA o programa de selección QuickFan.

Características acústicas

Espectro de potencia sonora Lw(A) en dB(A) por banda de frecuencia en Hz

	63	125	250	500	1000	2000	4000	8000		63	125	250	500	1000	2000	4000	8000
PF/EC-925-2M-0.5 IE5	48	63	61	73	70	74	76	63	PF/EC-1135-2T-4 IE5	58	73	71	83	80	84	86	73
PF/EC-925-2T-0.5 IE5	48	63	61	73	70	74	76	63	PF/EC-1135-4T-0.5 IE5	43	58	56	68	65	69	71	58
PF/EC-1028-2M-1 IE5	51	66	64	76	73	77	79	66	PF/EC-1240-2T-5.5 IE5	62	77	75	87	84	88	90	77
PF/EC-1028-2T-1 IE5	51	66	64	76	73	77	79	66	PF/EC-1240-4T-0.75 IE5	47	62	60	72	69	73	75	62
PF/EC-1028-4M-0.33 IE5	36	51	49	61	58	62	64	51	PF/EC-1445-4T-1.5 IE5	51	66	64	76	73	77	79	66
PF/EC-1028-4T-0.33 IE5	36	51	49	61	58	62	64	51	PF/EC-1650-4T-3 IE5	68	78	86	88	87	89	80	70
PF/EC-1031-2T-2 IE5	55	70	68	80	77	81	83	70	PF/EC-1856-4T-5.5 IE5	63	72	85	81	84	85	79	65
PF/EC-1031-4M-0.33 IE5	40	55	53	65	62	66	68	55	PF/EC-1663-4T-5.5 IE5	77	82	88	90	88	85	78	70
PF/EC-1031-4T-0.33 IE5	40	55	53	65	62	66	68	55	PF/EC-1871-6T-3 IE5	72	73	82	85	87	88	84	71

Dimensiones mm

Horizontal

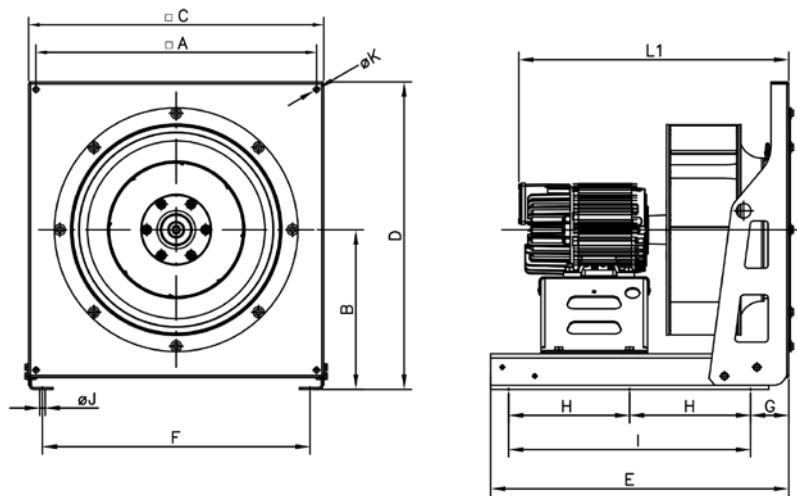

	□A	B	□C	D	E	F	G	H	I	ØJ	ØK	L1
PF/EC-H-925-2M-0.5-IE5	350	215	400	415	405	345	70	-	300	9	9	380
PF/EC-H-925-2T-0.5-IE5	350	215	400	415	405	345	70	-	300	9	9	390
PF/EC-H-1028-2M-1-IE5	375	215	400	415	405	345	70	-	300	9	9	435
PF/EC-H-1028-2T-1-IE5	375	215	400	415	405	345	70	-	300	9	9	406
PF/EC-H-1028-4M-0.33-IE5	375	215	400	415	405	345	70	-	300	9	9	395
PF/EC-H-1028-4T-0.33-IE5	375	215	400	415	405	345	70	-	300	9	9	406
PF/EC-H-1031-2T-2-IE5	375	215	400	415	505	345	70	-	400	9	9	422
PF/EC-H-1031-4M-0.33-IE5	375	215	400	415	505	345	70	-	400	9	9	411
PF/EC-H-1031-4T-0.33-IE5	375	215	400	415	505	345	70	-	400	9	9	422
PF/EC-H-1135-2T-4-IE5	475	270	500	520	505	445	70	-	400	9	9	506
PF/EC-H-1135-4T-0.5-IE5	475	270	500	520	505	445	70	-	400	9	9	458
PF/EC-H-1240-2T-5.5-IE5	475	270	500	520	505	445	70	-	400	9	9	530
PF/EC-H-1240-4T-0.75-IE5	475	270	500	520	505	445	70	-	400	9	9	495
PF/EC-H-1445-4T-1.5-IE5	580	335	630	650	605	575	70	-	500	9	9	542
PF/EC-H-1650-4T-3-IE5	600	335	630	650	705	575	70	-	600	9	9	653
PF/EC-H-1856-4T-5.5-IE5	700	430	760	810	705	705	70	-	600	9	9	688
PF/EC-H-1663-4T-5.5-IE5	700	430	760	810	805	710	70	-	700	11	9	770
PF/EC-H-1871-6T-3-IE5	800	545	960	1025	905	905	70	400	800	11	9	810

Dimensiones mm

Vertical

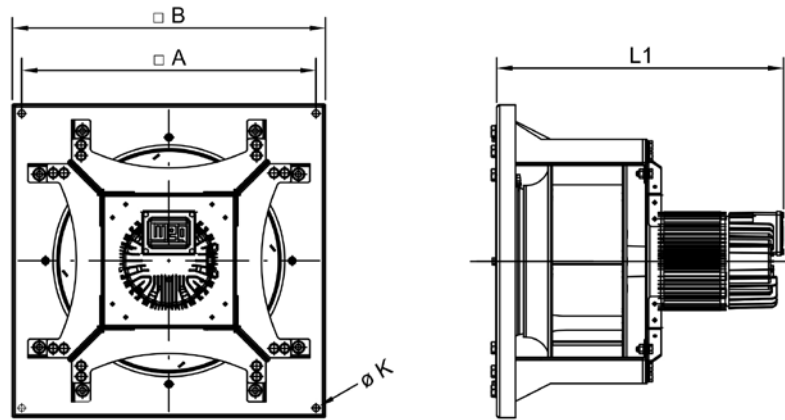

	□A	□B	ØK	L1
PF/EC-V-925-2M-0.5-IE5	367	400	11	380
PF/EC-V-925-2T-0.5-IE5	367	400	11	390
PF/EC-V-1028-2M-1-IE5	390	420	11	436
PF/EC-V-1028-2T-1-IE5	390	420	11	407
PF/EC-V-1028-4M-0.33-IE5	390	420	11	397
PF/EC-V-1028-4T-0.33-IE5	390	420	11	407
PF/EC-V-1031-2T-2-IE5	434	470	11	424
PF/EC-V-1031-4M-0.33-IE5	434	470	11	413
PF/EC-V-1031-4T-0.33-IE5	434	470	11	424
PF/EC-V-1135-2T-4-IE5	470	500	11	506
PF/EC-V-1135-4T-0.5-IE5	470	500	11	458
PF/EC-V-1240-2T-5.5-IE5	519	550	11	529
PF/EC-V-1240-4T-0.75-IE5	519	550	11	494
PF/EC-V-1445-4T-1.5-IE5	580	630	11	542
PF/EC-V-1650-4T-3-IE5	635	670	11	652
PF/EC-V-1856-4T-5.5-IE5	689	730	11	693
PF/EC-V-1663-4T-5.5-IE5	800	840	11	765

Curvas características

Q= Caudal en m³/h, m³/s y cfm

Pe= Presión estática en mmH₂O, Pa e inwg

925-2M-0.5

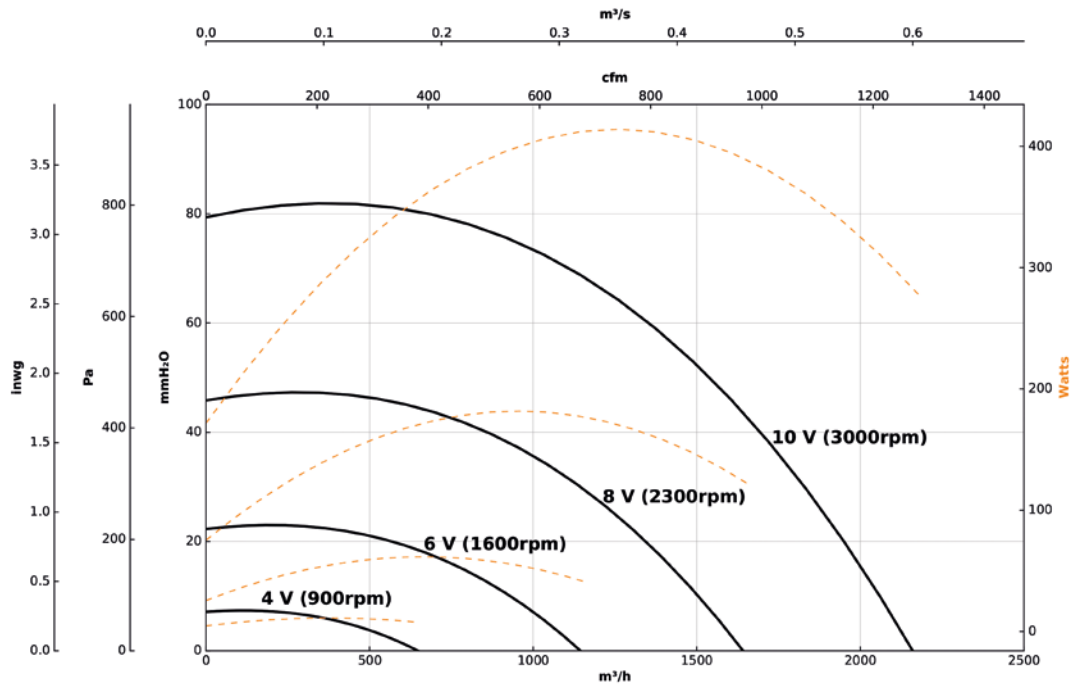

925-2T-0.5

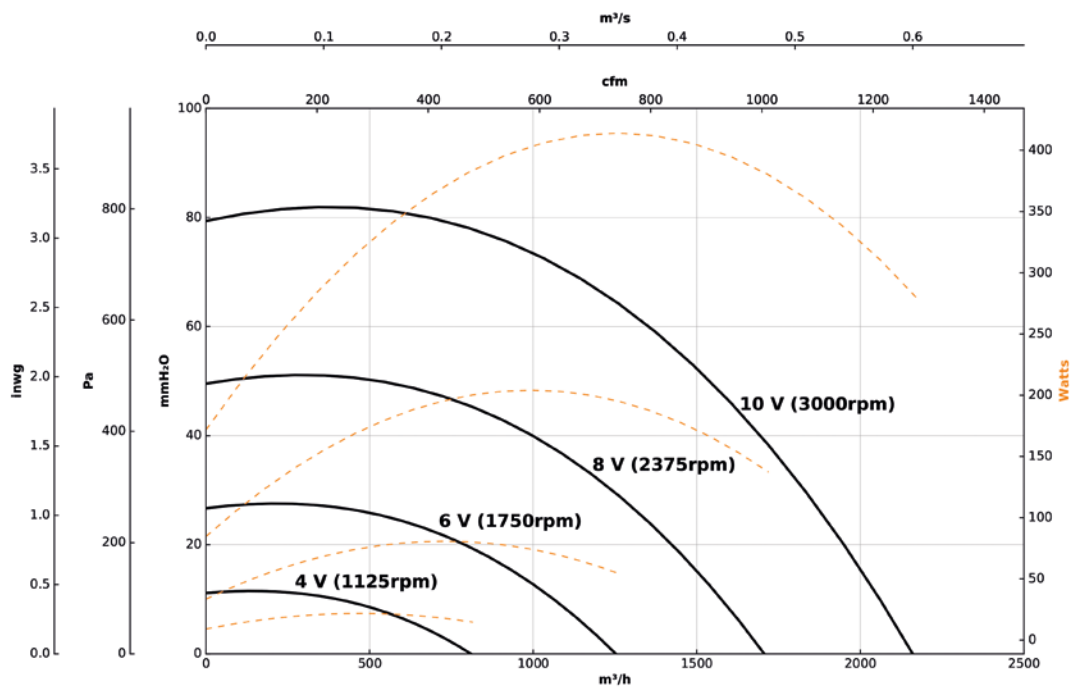

Curvas características

Q= Caudal en m³/h, m³/s y cfm

Pe= Presión estática en mmH₂O, Pa e inwg

1028-2M-1

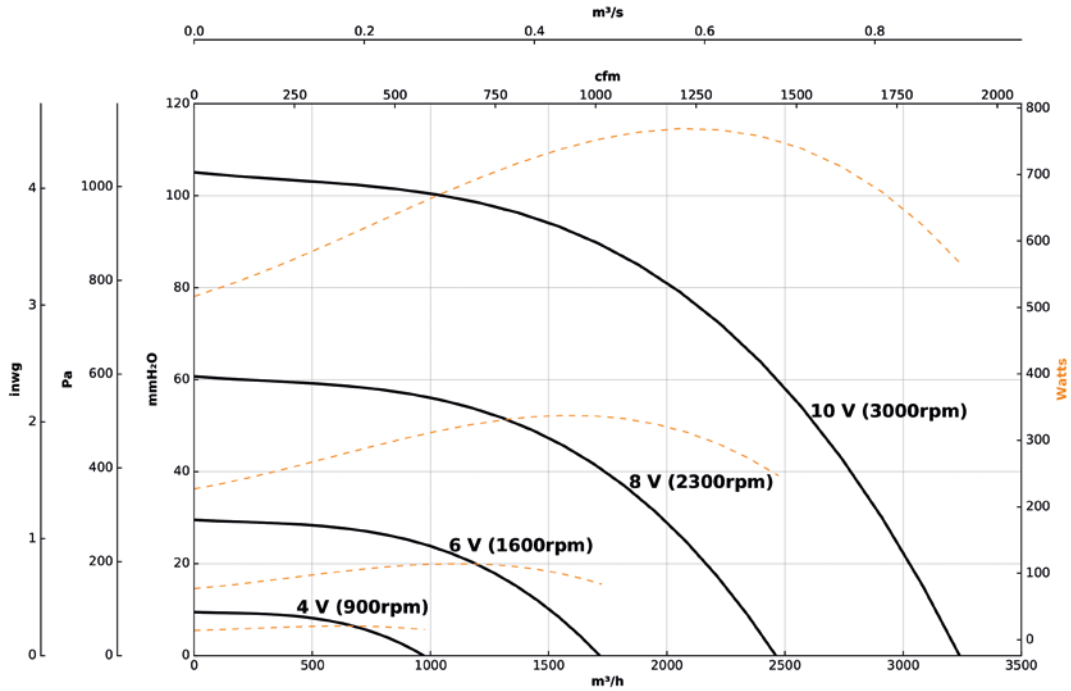

1028-2T-1

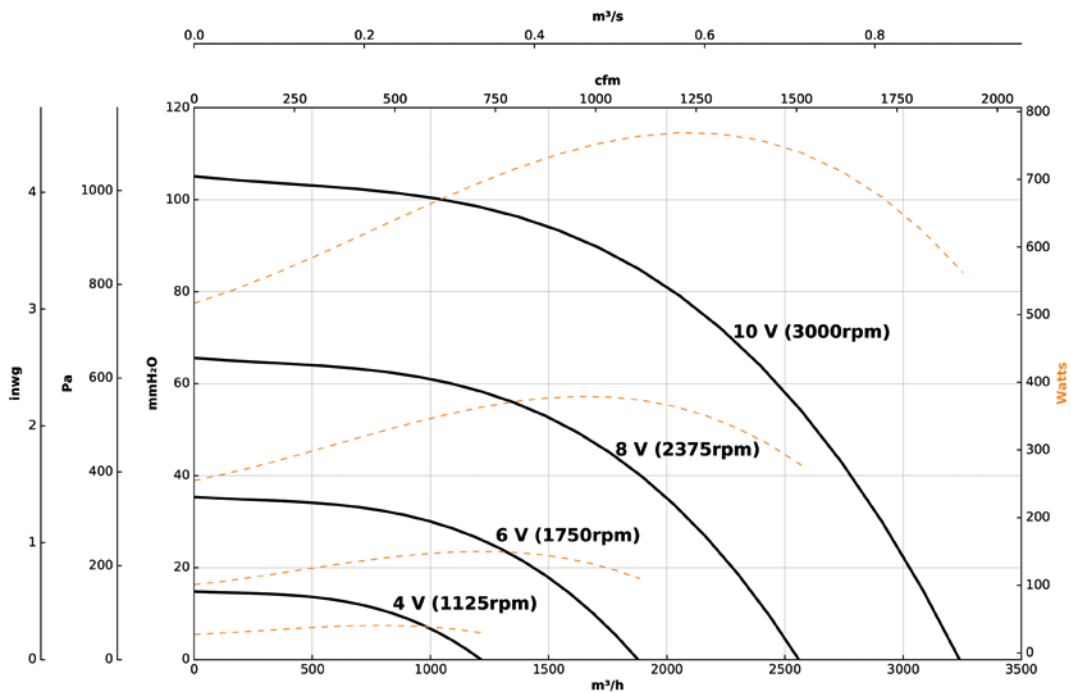

Curvas características

Q= Caudal en m³/h, m³/s y cfm

Pe= Presión estática en mmH₂O, Pa e inwg

1028-4M-0.33

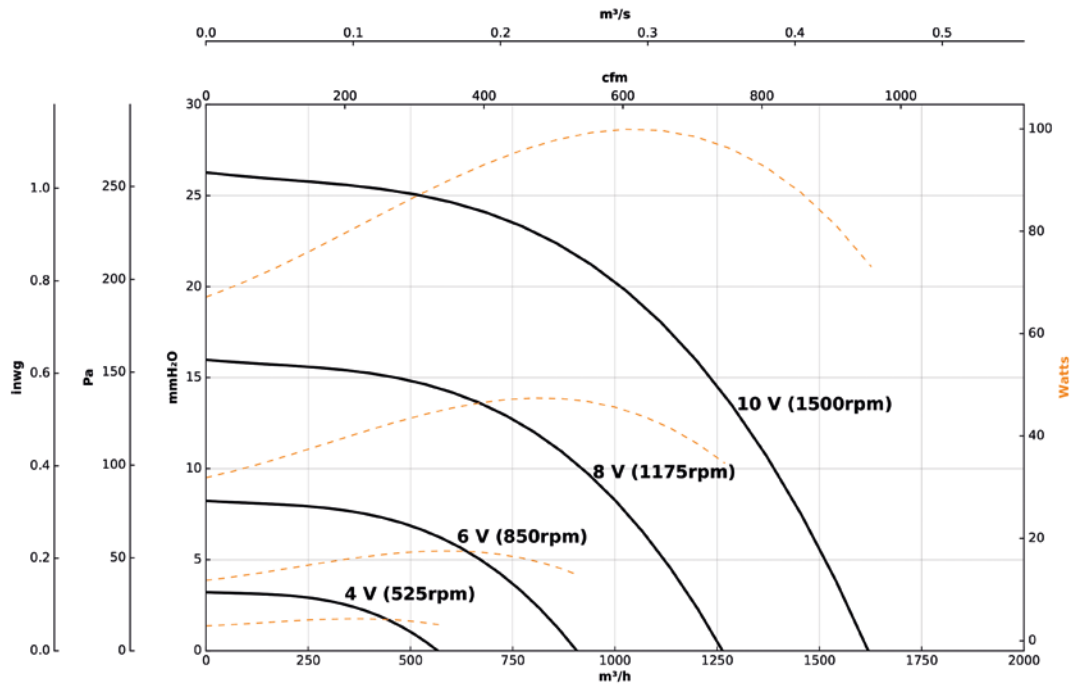

1028-4T-0.33

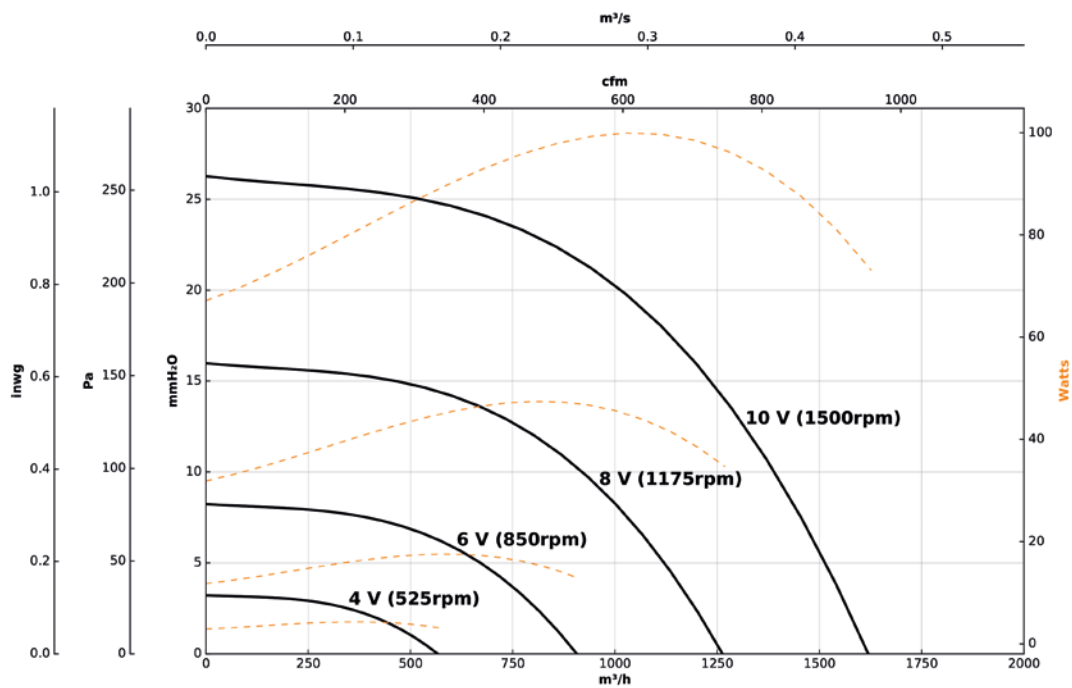

Curvas características

Q= Caudal en m³/h, m³/s y cfm

Pe= Presión estática en mmH₂O, Pa e inwg

1031-2T-2

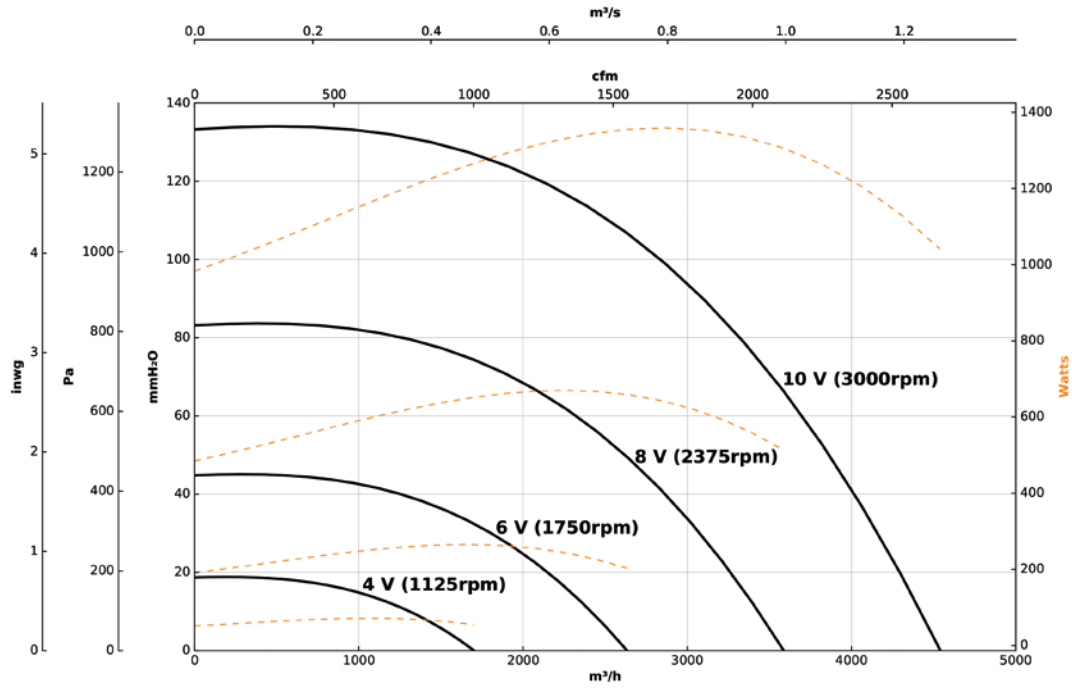

1031-4M-0.33

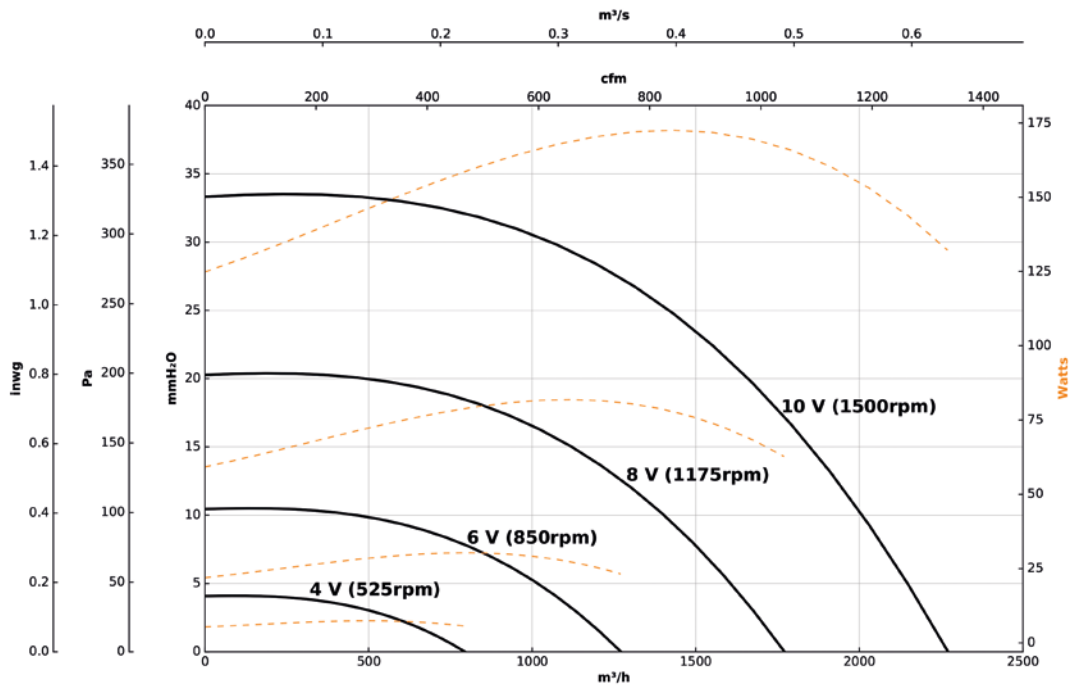

Curvas características

Q= Caudal en m³/h, m³/s y cfm

Pe= Presión estática en mmH₂O, Pa e inwg

1031-4T-0.33

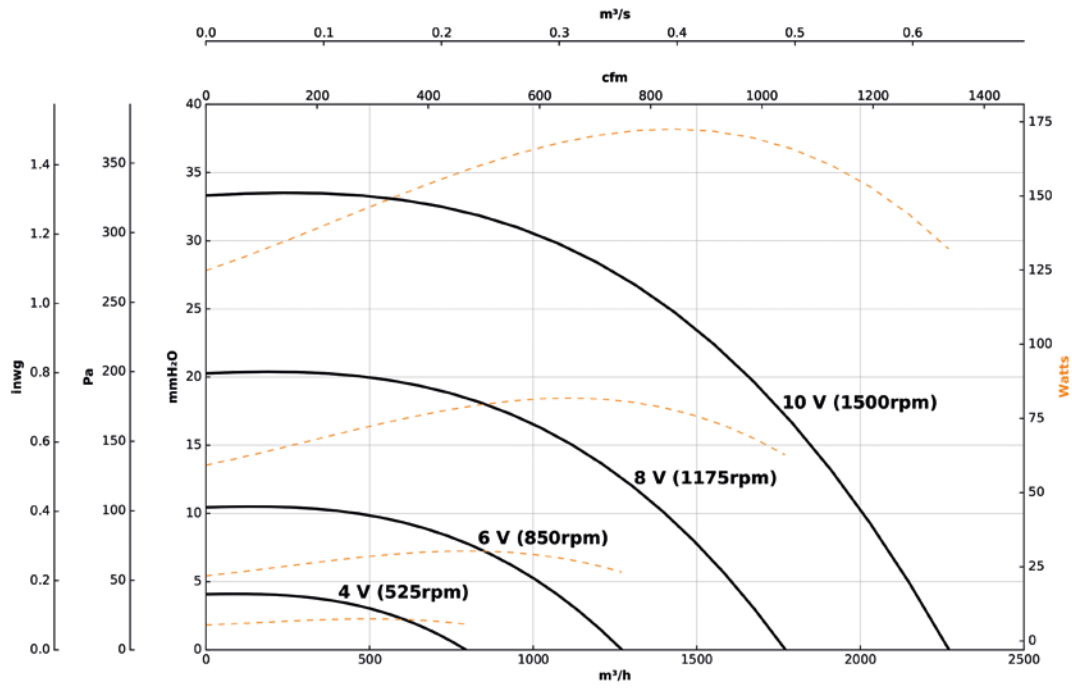

1135-2T-4

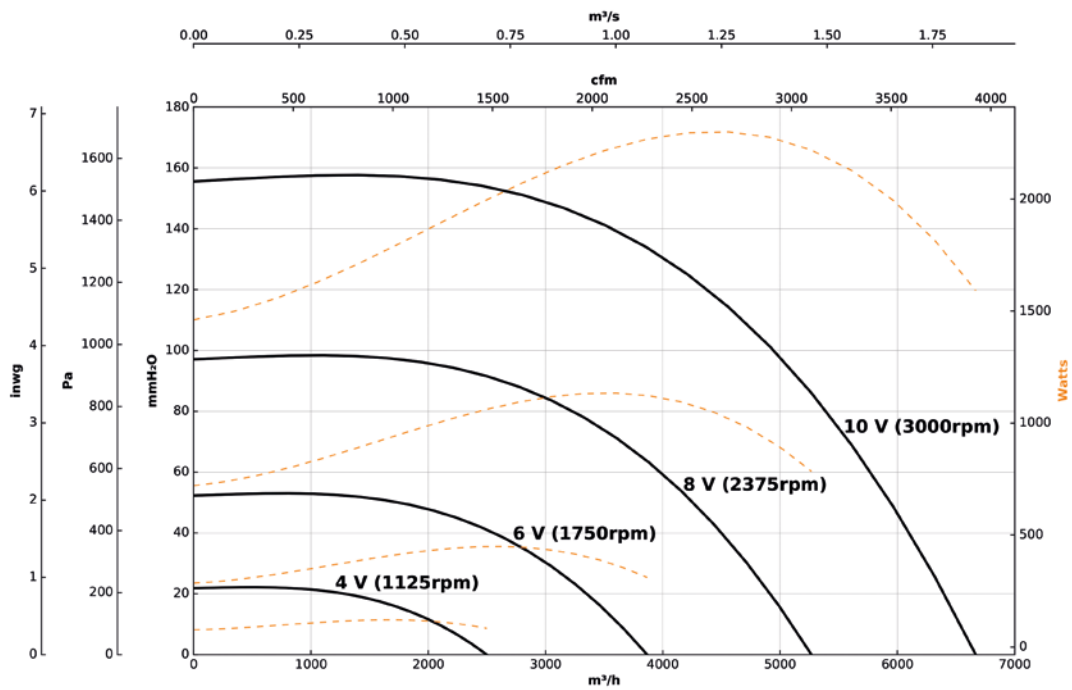

Curvas características

Q= Caudal en m³/h, m³/s y cfm

Pe= Presión estática en mmH₂O, Pa e inwg

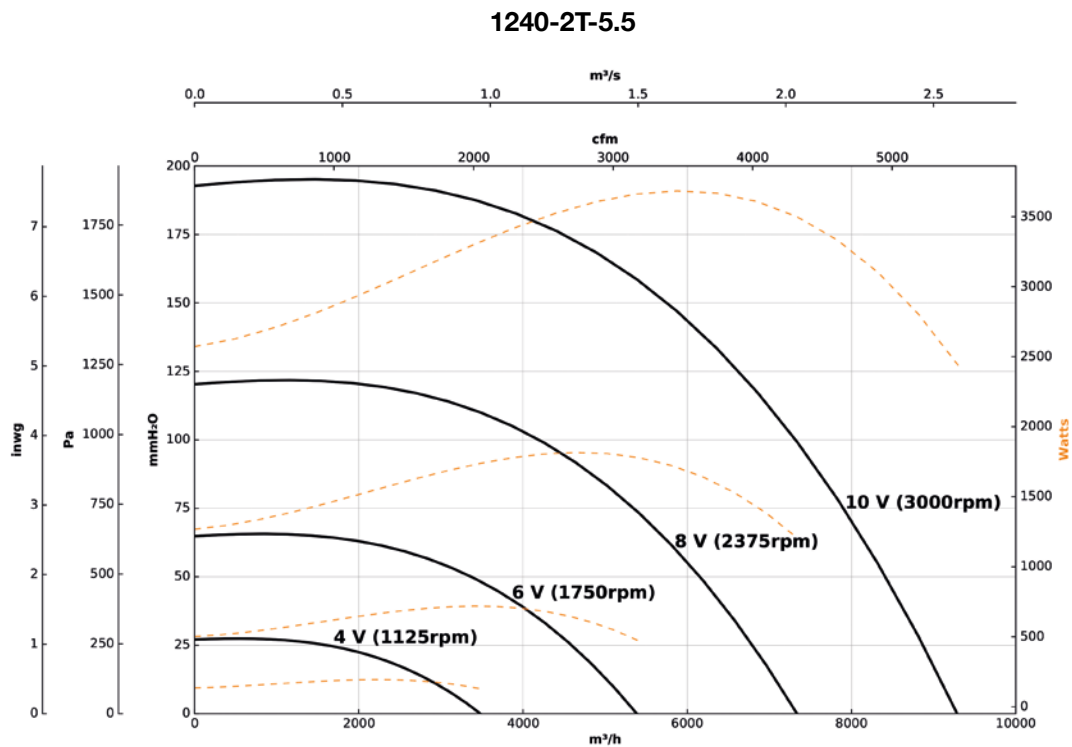
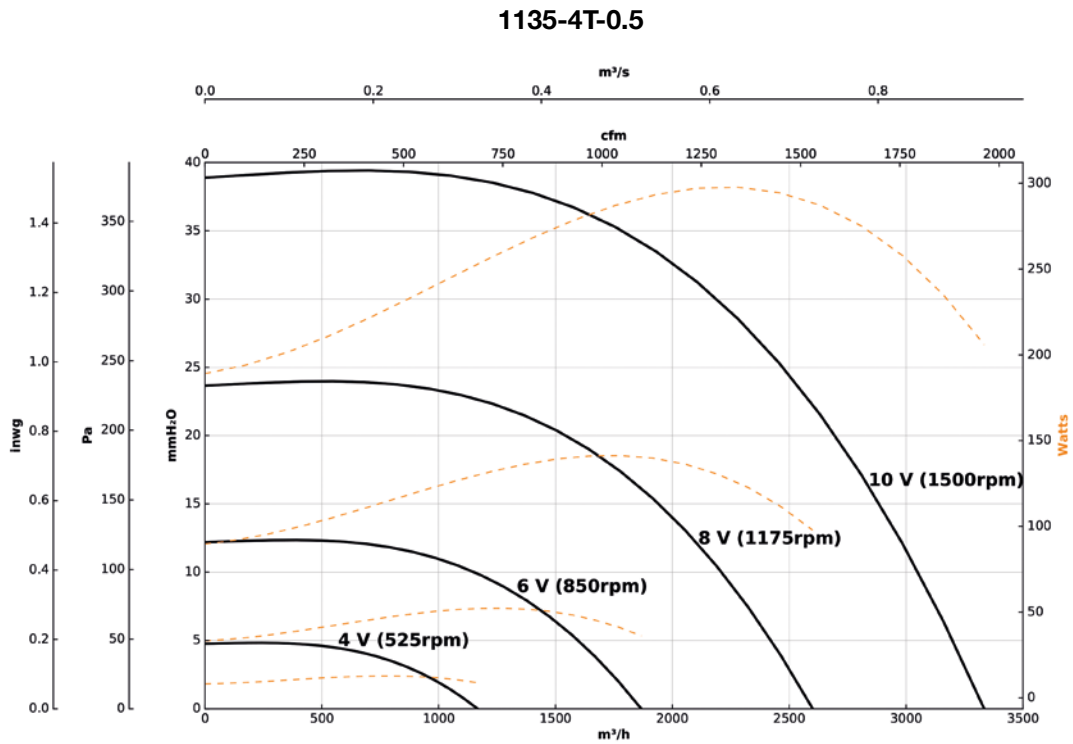

Curvas características

Q= Caudal en m³/h, m³/s y cfm

Pe= Presión estática en mmH₂O, Pa e inwg

1240-4T-0.75

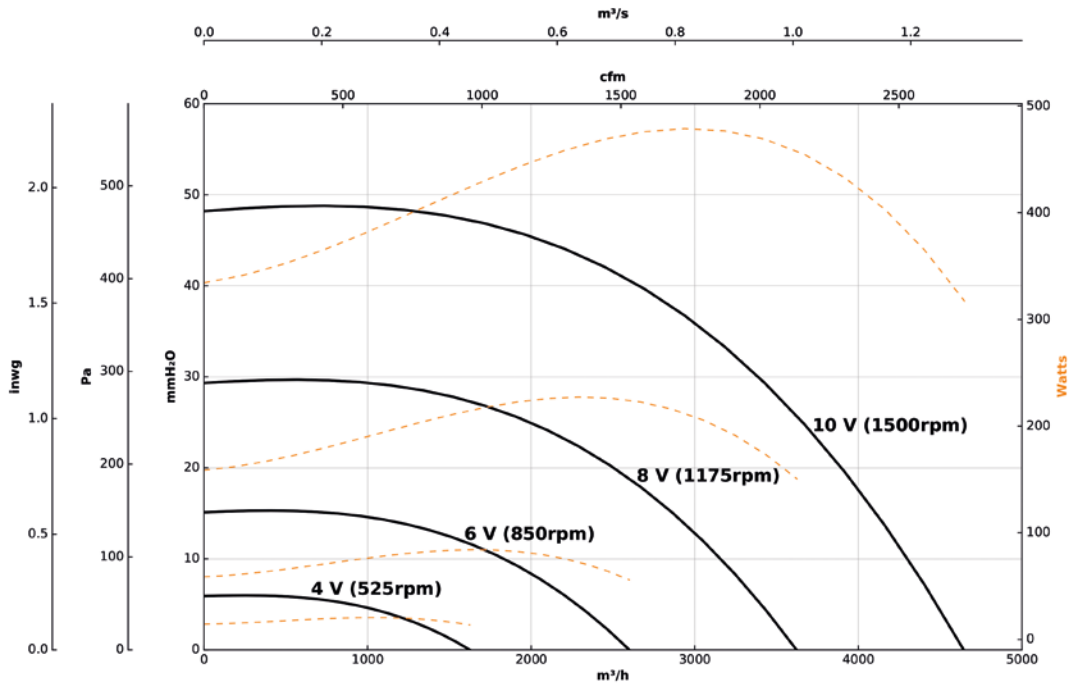

1445-4T-1.5

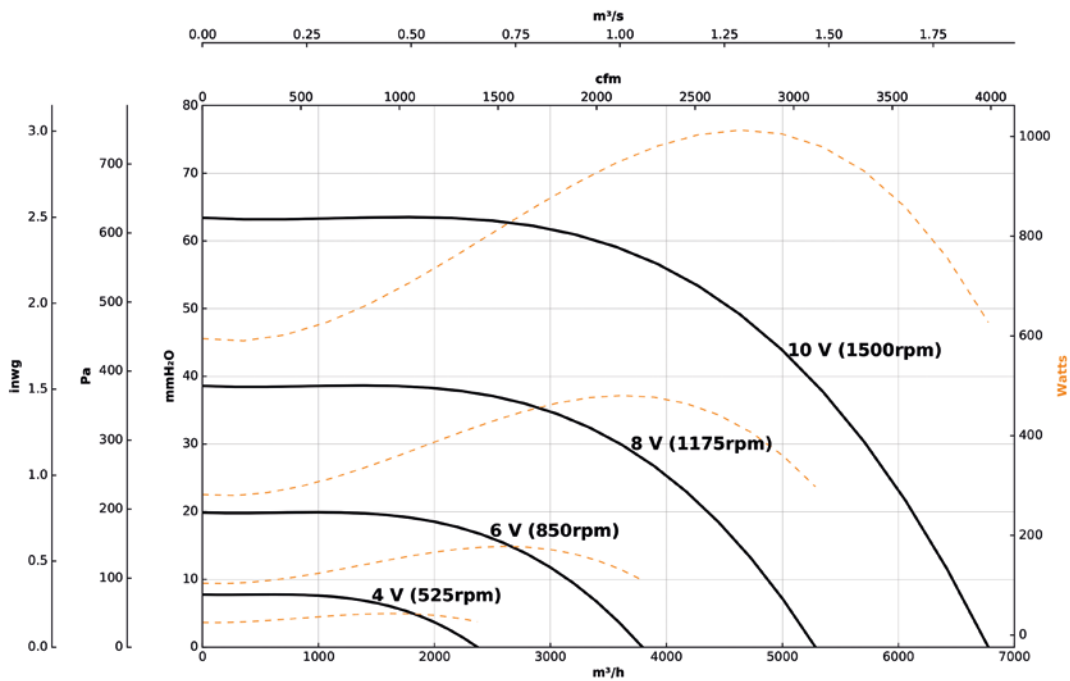

Curvas características

Q= Caudal en m³/h, m³/s y cfm

Pe= Presión estática en mmH₂O, Pa e inwg

1650-4T-3

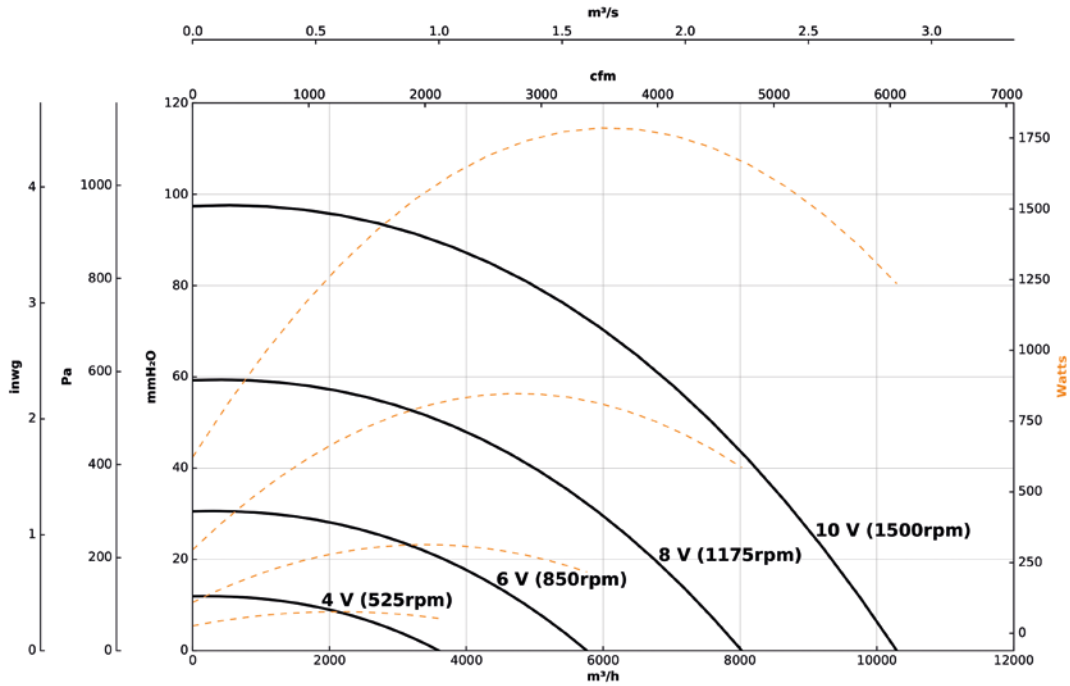

1856-4T-5.5

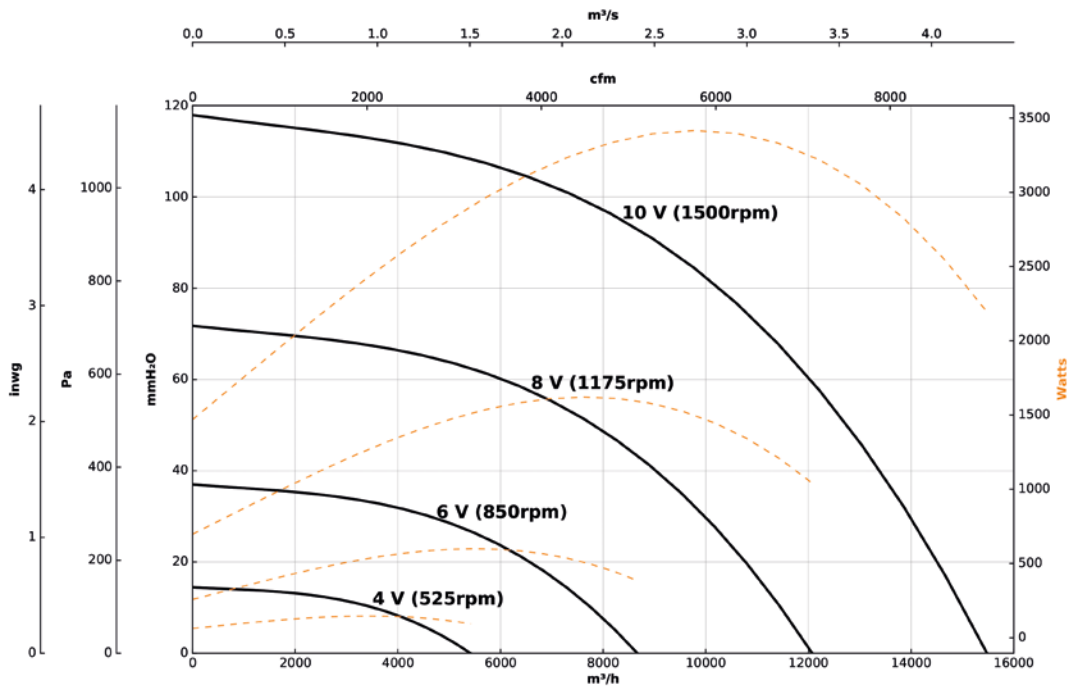

Curvas características

Q= Caudal en m³/h, m³/s y cfm

Pe= Presión estática en mmH₂O, Pa e inwg

1663-4T-5.5

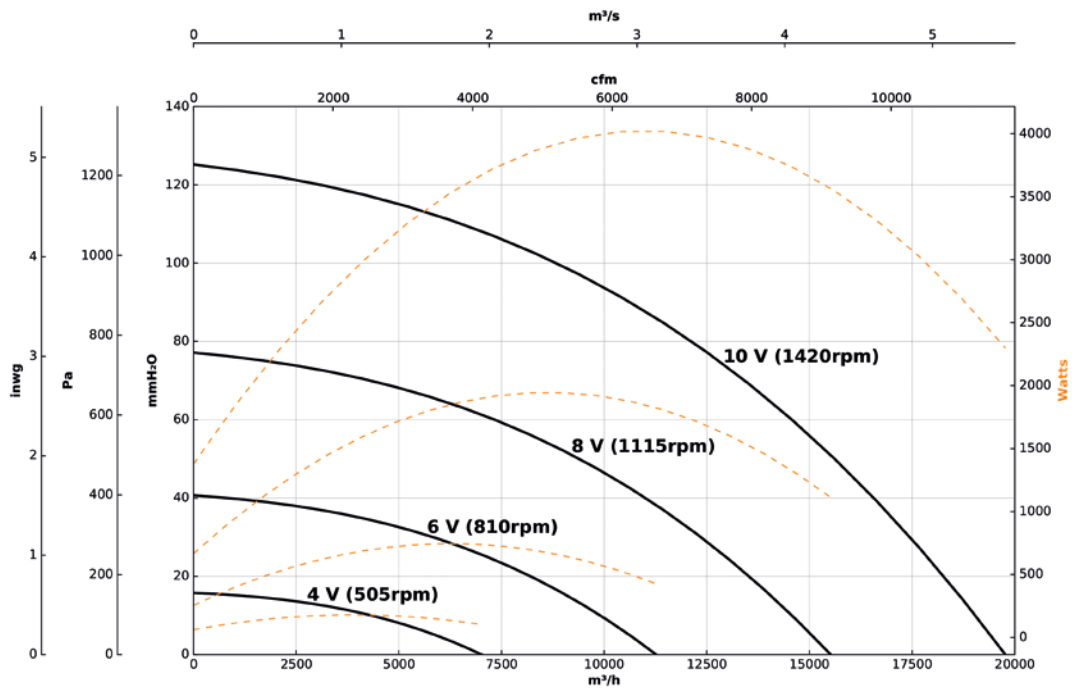

1871-6T-3

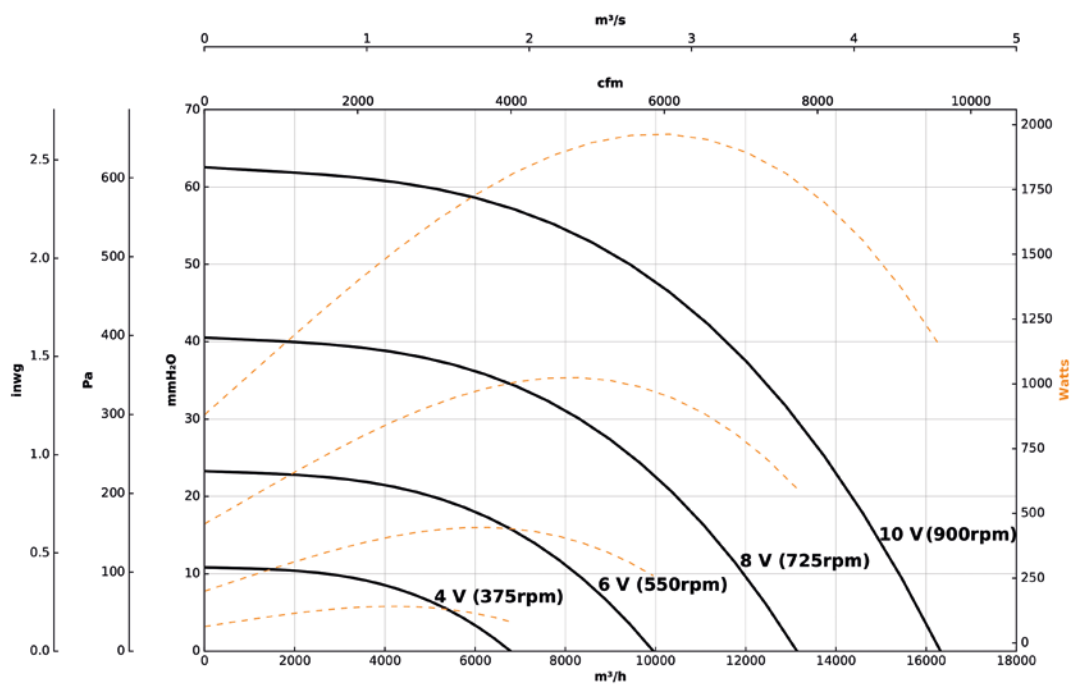

Toma de presión

Caudal de aire → Q [m³/h]
 Factor de calibración → K
 Diferencia de presión → Δp [Pa]

$$Q = K x \sqrt{\Delta p}$$

	Factor K*
PF/EC-925	77
PF/EC-1028	94
PF/EC-1031	107
PF/EC-1135	143
PF/EC-1240	168
PF/EC-1445	245
PF/EC-1650	225
PF/EC-1856	310
PF/EC-1663	397
PF/EC-1871	513

* Valores referidos a p = 1,2 kg/m³ y a 20 °C.

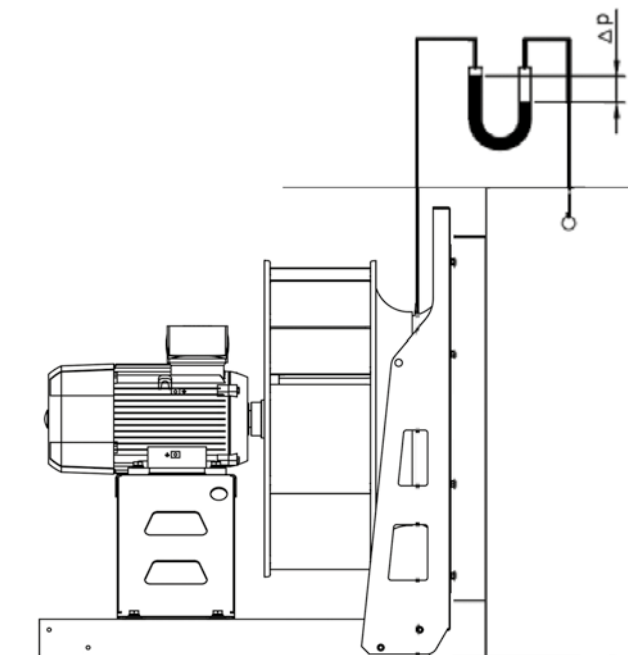

Accesorios



SI-PRESIÓN



INT



EC CONTROL



MTP



RPA



B



BD